

Electro-Voice®

a MARK IV company

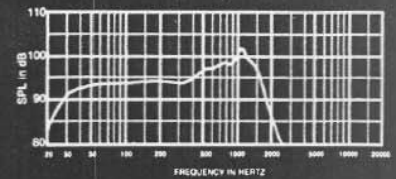

FIGURE 1
Axial Frequency Response, 1 Watt/1 Meter
12 Cubic Foot Enclosure Tuned to 27 Hz

EVX-1800

**18-Inch
Very-Low-Frequency
Reproducer**

SPECIFICATIONS

Power Handling:
1500 watts continuous program

Voice Coil Diameter:
102 mm (4 in.)

**Sensitivity (SPL/1 W/1 M),
100-800-Hz Average:**
95 dB

Impedance,
8 ohms

Frequency Response:
20-1 kHz

Highest Recommended Crossover:
200 Hz

Magnet Assembly Weight:
11.3 kg (25 lbs)

THIELE-SMALL PARAMETERS

f_s : 20 Hz
 R_e : 5.0 ohms
 Q_{ts} : 0.264
 Q_{ms} : 7.53
 Q_{es} : 0.274
 V_{as} : 767 L (27 cu. ft.)
 S_D : 0.125 sq. m (193 sq. in.)
 X_{max} : 15 mm (0.60 in.)
Displacement Limit:
 56 mm (2.2 in.) peak to peak
 η_o : 2.16%
 P_e : 850 watts EIA RS-426A
 750 watts continuous sine wave

DESCRIPTION

The EVX-1800 very-low-frequency transducer is designed for professional sound reinforcement or studio monitoring applications that require maximum subwoofer output with extremely low distortion. EVX-1800 provides unprecedented high power capacity and linear cone-excursion ability made possible by the HeatWick™ total-thermal-engineering design

and the revolutionary Internal Tandem Disk™ voice-coil suspension. The result is low-frequency impact and "punch" that is simply not provided by traditional professional designs. The 18-inch EVX-1800 has more output capability than any high-performance 18-inch woofer.

The proprietary HeatWick design actually "wicks" heat away from the voice coil, significantly increasing power handling and long-term reliability. A special frame extension and elongated pole piece provide a metal surface with close proximity to the entire length of the voice coil, providing a major heat-transfer path. Also, the 102-mm (4-in.) diameter voice coil is 50% longer than conventional "long-throw" coils, to give additional power handling and virtually eliminate dynamic-range power compression.

The EVX-1800 Internal Tandem Disk suspension provides the highest excursion capability (over 2 inches peak-to-peak) of any woofer, for greatly increased low-bass output and the lowest distortion possible at high levels. The unique fiberglass-epoxy suspension is formed from concentric cantilever disks attached inside the voice-coil former. This suspension/voice-coil assembly is fixed to the pole piece, with cone excursion allowed by the flexure of the suspension disks. Careful choices of materials and disk geometry allow high radial rigidity to reduce the risk of voice-coil "rubs" and provide higher reliability than conventional cloth-spider suspensions.

Additionally, a Flux Demodulation Device (FDD™) reduces distortion in the critical midband by providing a "short circuit" effect to prevent modulation of the static magnetic field. To further increase reliability, PROTEF™, a Teflon®-based coating, is applied to the inner diameter of the top plate and FDD. PROTEF

lubricates any rubbing contact and electrically insulates the coil to guard against violent short-term power peaks.

A ribbed carbon-fiber composite cone with an extremely high stiffness-to-weight ratio gives the EVX-1800 increased resistance to cone collapse and breakup, without added efficiency-robbing mass, as compared to conventional paper designs.

FEATURE HIGHLIGHTS

- **HeatWick™ Design**
Provides advanced thermal engineering to "wick" heat away from the voice-coil for increased power handling and reliability.
- **Internal Tandem Disk™**
Voice-coil suspension provides a 50-mm (2-in.) peak-to-peak excursion for unprecedented low-bass output. High radial rigidity keeps coil centered in the gap at explosive volumes.
- **Extended-Length 102-mm (4-in.) Voice Coil**
Has nearly twice the surface area of any other woofer to virtually eliminate dynamic-range power compression.
- **Carbon-Fiber Composite Cone**
For added protection against cone collapse and breakup, without adding efficiency-robbing weight.
- **Rubber Mounting-Flange Gasket**
Provides a reusable seal for front or rear mounting, completely surrounding the frame flange.
- **1,500-Watt Continuous Program**
Power capacity, without efficiency sacrifice, for extremely high output with low distortion.

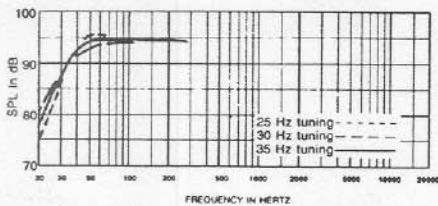

FIGURE 2A — EVX-1800 Single-Driver Low-Frequency Performance: 223-L (8-ft³) Enclosure

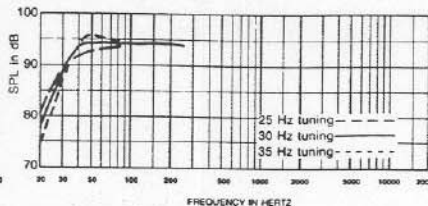

FIGURE 2B — EVX-1800 Single-Driver Low-Frequency Performance: 283-L (10-ft³) Enclosure

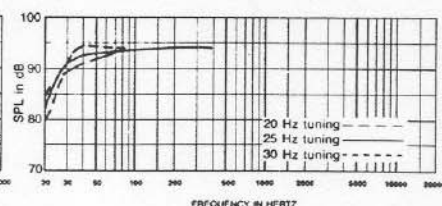

FIGURE 2C — EVX-1800 Single-Driver Low-Frequency Performance: 336-L (12.5-ft³) Enclosure

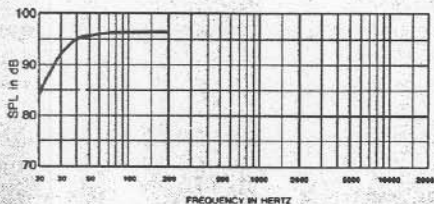

FIGURE 2D — EVX-1800 Multiple-Driver Low-Frequency Performance: 2 Drivers in a 566-L (20-ft³) Box or 2 283-L (10-ft³) Boxes in Close Proximity Tuned to 25 Hz

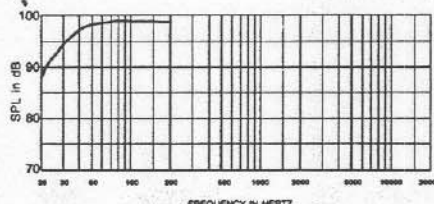

FIGURE 2E — EVX-1800 Multiple-Driver Low-Frequency Performance: 4 Drivers in a 1132-L (40-ft³) Box or 4 283-L (10-ft³) Boxes in Close Proximity Tuned to 22 Hz

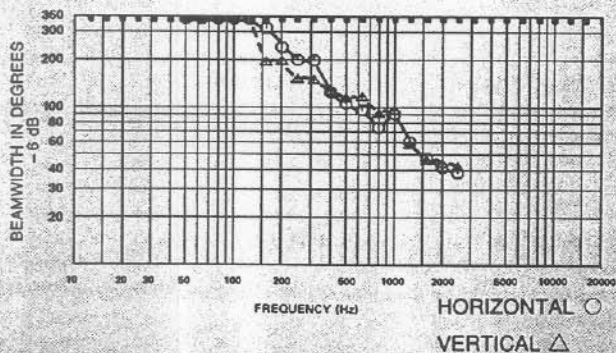

FIGURE 3 — Beamwidth vs. Frequency EVX-1800/TL3512 in a 255-L (9.0-ft³) Enclosure

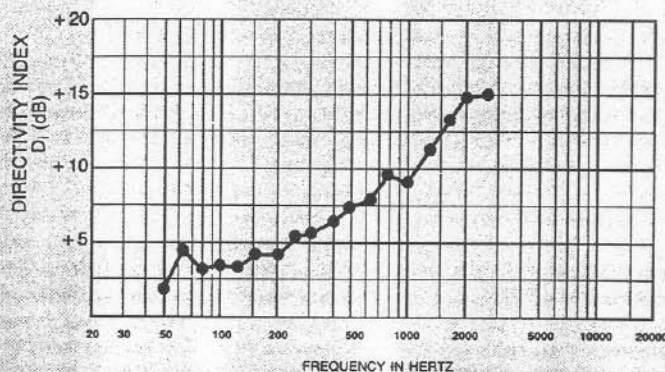

FIGURE 4 — Directivity Index vs. Frequency EVX-1800/TL3512 in a 255-L (9.0-ft³) Enclosure

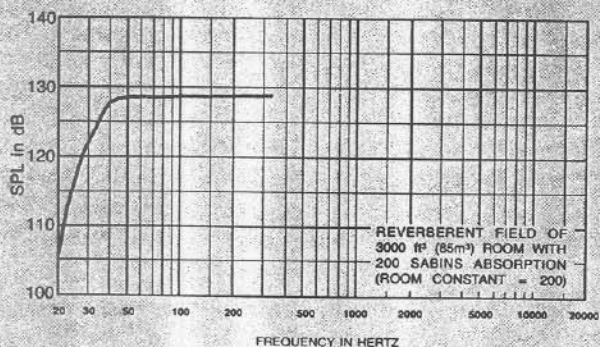

FIGURE 5 — Theoretical Low-Frequency Maximum Acoustic Output vs. Frequency 283-L (10-ft³) Enclosure Tuned to 30 Hz

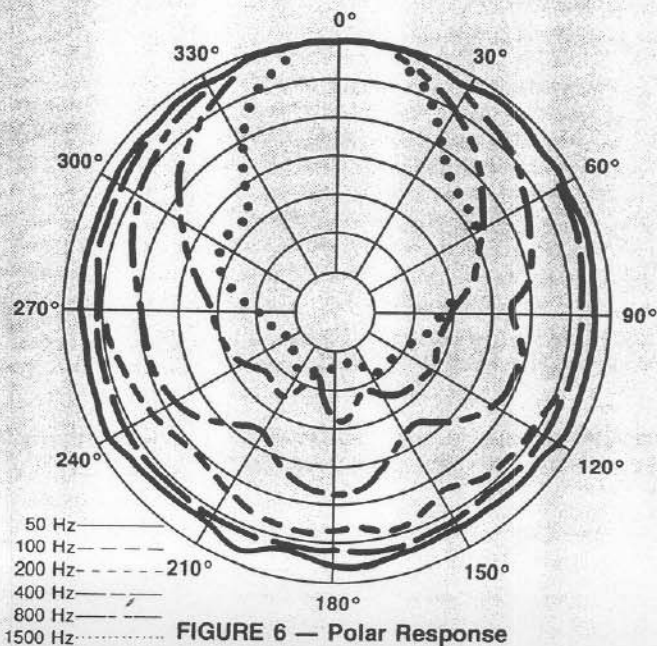

FIGURE 6 — Polar Response

DIRECTIONAL PERFORMANCE

The directional characteristics of the EVX-1800 in the TL3512 256-L (9-ft³) vented enclosure were measured by running a set of polar responses in EV's large anechoic chamber. The test signal was octave-band-limited pseudo-random pink noise centered at the ISO standard frequencies.

The curves show horizontal (side-to-side) dispersion when the enclosure's long axis is vertical. The vertical (up-and-down) polar responses deviate only slightly from the horizontal responses due to box geometry. Typical data is provided in Figures 3 and 4 which indicate 6-dB-down beamwidth versus frequency and directivity factor, respectively, for an EVX-1800 in the TL3512 enclosure.

POWER HANDLING TEST

To our knowledge, Electro-Voice was the first U.S. manufacturer to develop and publish a power test closely related to real-life conditions. First, we use a random noise input signal because it contains many frequencies simultaneously, just like real voice or instrument program. Second, our signal contains more energy at extremely high and low frequencies than typical actual program, adding an extra measure of reliability. Third, the test signal includes not only the overall "long-term average" or "continuous" level — which our ears interpret as loudness — but also short-duration peaks which are many times higher than the average, just like actual program. The long-term average level stresses the speaker thermally (heat). The instantaneous peaks test mechanical reliability (cone and diaphragm excursion).

Specifically, the EVX-1800 is designed to withstand the power test described in EIA Standard RS-426A. The EIA test spectrum is applied for eight hours. To obtain the spectrum, the output of a white noise generator (white noise is a particular type of random noise with equal energy per bandwidth in Hz) is fed to a shaping filter with 6-dB-per-octave slopes below 40 Hz and above 318 Hz. When measured with the usual constant-percentage-bandwidth analyzer (one-third octave), this shaping filter produces a spectrum whose 3-dB-down points are at 100 Hz and 1200 Hz with a 3-dB-per-octave slope above 1200 Hz. The signal has a 6-dB crest factor. This procedure provides a rigorous test of both thermal and mechanical failure modes.

The EVX-1800 has also been power tested with a two hour sine wave at minimum impedance so that competitive comparisons can be made using consistent methods. Continuous program power is defined as 3-dB above (double) the continuous sine-wave power rating.

RECOMMENDED ENCLOSURES

The most extended, lowest distortion and best controlled bass performance is usually realized in properly designed vented enclosures. In such designs, the vent, or port, actually provides the lowest octave of output. The vent is driven to full acoustic output by a relatively small motion of the speaker cone itself, acting through the air contained within the enclosure. The excursion of the EVX-1800 at these frequencies is much reduced compared to sealed or open back enclosures, directly reducing harmonic distortion and the possibility of speaker "bottoming." Several specific vented-enclosure recommendations are on the previous page. Alternate tunings are given so that designers can tailor the low-frequency response to their specific needs. Figure 5 shows the maximum acoustic power output versus frequency. The maximum output is limited by either: 1) the thermal, power handling capacity, or, 2) the speaker's maximum cone excursion capabilities, whichever occurs first. Also provided are recommended enclosures for multiple driver configurations.

STEP-DOWN OPERATION

For extended low-frequency operation, the vent area can be reduced by one-half, thereby tuning the enclosure to the "step down" mode. In step-down, the tuning frequency is reduced by half an octave (a factor of 0.7). The resulting alignment is then equalized for flat response. This procedure results in one-half octave lower bass without any excursion penalty.

ARCHITECTS' AND ENGINEERS' SPECIFICATIONS

The low-frequency transducer shall have a nominal diameter of 460 mm (18 in.), overall depth not greater than 211 mm (8.42 in.), and weigh no more than 14 kg (31 lb). The frame shall be made of die-cast aluminum to resist deformation. The magnetic assembly shall have an extended pole-piece to reduce inductive variances with excursion, and provide a symmetrical magnetic field at the voice coil gap. Two aluminum rings shall encircle the pole piece above and below the magnetic gap, and shall have internal diameters concentric with the internal diameter of the steel top-plate. The upper ring shall be part of the loudspeaker frame. Both rings act to reduce flux modulation and provide a heat-transfer path from the outer diameter of the voice coil. The inner diameter of the steel top plate and the lower aluminum ring shall be Teflon® coated.

The voice coil shall be 102 mm (4 in.) in diameter and 35.5 mm (1.4 in.) in winding length, and shall be made of edgewound

aluminum ribbon. The voice coil shall be suspended in the magnetic gap by two spiders. The spiders shall be attached to the inside diameter of the coil form and center of the pole piece. The spiders shall be made of FRP G-10 or equivalent. The voice coil shall produce a force of not less than 20.3 Newtons (Tesla-Ampere-Meters) with a dc current of 1 ampere

Performance specifications of a typical production unit shall be as follows. Measured sensitivity [SPL at 1 m (3.3 ft.) with 1-watt input, averaged between 100-800-Hz pink noise] shall be at least 95 dB. The half space reference efficiency shall be at least 2.1%. The usable frequency response shall be 15 Hz to 1500 Hz, and the nominal impedance shall be 8 ohms. The rated power for the loudspeaker shall be 1500 watts normal program material.

The low-frequency transducer shall be the Electro-Voice EVX-1800.

AES SPECIFICATIONS

The following specifications are in accordance with the "AES Draft Recommended Practice for Specification of Loudspeaker Components Used in Professional Sound Reinforcement Systems — 1983."

Dimension and Weight,

Outer Diameter:	46 cm (18.3 in.)
Depth:	21 cm (8.46 in.)
Bolt Hole Diameter:	7.1 mm (0.281 in.)
Net Weight:	14 kg (31 lb)
Shipping Weight:	16.8 kg (37 lb)

Mounting:

The EVX-1800 may be front- or rear-mounted against either surface of the mounting flange and requires a 422-mm (16.6-in.) diameter cutout and a 438-mm (17.25-in.) bolt circle. Normal fasteners up to 6 mm (¼ in.) will fit through the eight holes in the frame. Front mounting is simplest using the optional SMH-1 speaker mounting kit.

Electrical Connections:

The EVX-1800 is fitted with a pair of chrome-plated frame-mounted connectors with color-coded ends. Electrical connection is made by pushing down, inserting wire completely through the rectangular slot and releasing pressure. One conductor of #9 AWG stranded, #8 AWG solid, a pair of twisted #15 AWG stranded or a pair of #14 AWG solid conductors will fit. A positive electrical signal applied to the red (+) terminal will displace the cone away from the magnet, thus producing a positive acoustic pressure.

ADDITIONAL DESCRIPTIVE INFORMATION:

- Voice-Coil Material:
Aluminum
- Voice-Coil Insulation:
Polyimide, 220 degree C rating
- Coil Form:
Polyimide
- Magnet Frame:
Cast aluminum
- Thermal Rise after Power Test:
82 degrees C (147 degrees F)
- Recommended Enclosures:
6-15 cubic foot (170 L-424 L)
- Magnet Plating:
Bright cadmium

- Physical Constants,
- Effective Piston Diameter:
398 (15.7 in.)
- Total Moving Mass:
0.155 kg
- Voice-Coil Winding Depth:
36 mm (1.4 in.)
- Top Plate Thickness at Voice Coil:
8.9 mm (0.35 in.)
- Z_{min}:
7 ohms
- Bl Factor:
20.3 Tm
- Thiele-Small Parameters:
- f_s: 20 Hz
- R_e: 5.0 ohms
- Q_{ts}: 0.264
- Q_{ms}: 7.53
- Q_{as}: 0.274
- V_{as}: 767 L (27.3 cu. ft.)
- S_d: 0.125 sq. m (194. sq. in.)
- X_{max}: 15 mm (0.60 in.)
- η_c: 2.16%
- P_s: 850 watts EIA RS-426A
750 watts continuous sine wave

Response in Standard Baffle

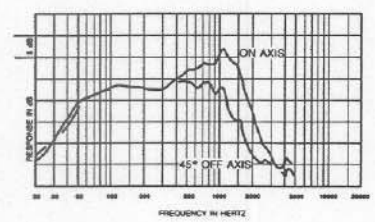

NOTE: AES requires a large, planar baffle or this test, WHICH IS INTENDED TO SHOW SMOOTHNESS AND OFF-AXIS RESPONSE, NOT BASS RESPONSE. This has proven to be inconvenient and prohibitive, due to its size. Here, we have chosen our lab standard low-diffraction 12-cubic-foot test enclosure, which will demonstrate the same characteristics as the "AES standard baffle."

Distortion Response

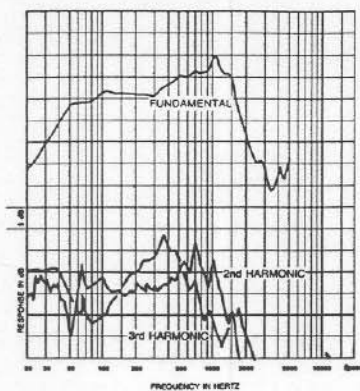

8.5 WATTS

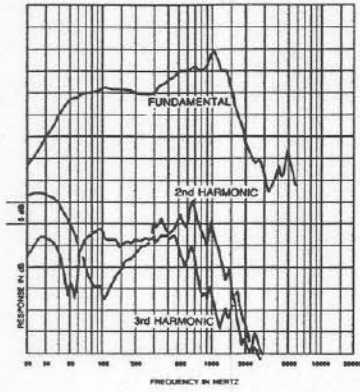

85 WATTS

Impedance Response:

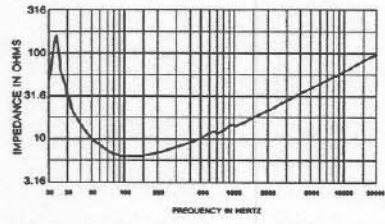

MULTIPLE DRIVER APPLICATION:

When used in arrays and multiple driver bass boxes, the system Thiele-Small parameters can be synthesized as follows. This data should be used for multiple-driver configurations.

Two (2) Drivers:

- f_s: 19.5 Hz
- Q_{ts}: 0.274
- V_{as}: 53.8 cu. ft. (1522 L)

Four (4) Drivers:

- f_s: 18.7 Hz
- Q_{ts}: 0.282
- V_{as}: 109.0 cu. ft. (3085 L)

Designers will find the following equation useful in tuning their enclosures:

$$L_v = \frac{S_v}{3.7 \times 10^{-4} V_B f_B^2} - K r$$

- Where:
- L_v = Length of vent or thickness of baffle, for hole in baffle, in inches
- S_v = Area of vent in square inches
- V_B = Volume of box in cubic feet
- f_B = Box tuning in Hz
- r = Radius of vent in inches
- K = 1.7 for a hole in baffle 1.5 for a tube in inches

IMPORTANT NOTE ON GRILLE COVERS:

Because of the extremely high excursion capability of the EVX-1800 it is important that users leave at least 1.1 inch clearance between the front gasket and a grille cover. A suggested grille cover that will provide this protection is Middle Atlantic Audio part # SGP-EV-18 or equivalent.

WARRANTY (Limited)

Electro-Voice Speakers and Speaker Systems (excluding active electronics) are guaranteed for five years from date of original purchase against malfunction due to defects in workmanship and materials. If such malfunction occurs, unit will be repaired or replaced (at our option) without charge for materials or labor if delivered prepaid to the proper Electro-Voice service facility. Unit will be returned prepaid. Warranty does not extend to finish, appearance items, burned coils, or malfunction due to abuse or operation under other than specified conditions, including cone and/or coil damage resulting from improperly designed enclosures, nor does it extend to incidental or consequential damages. Some states do not allow the exclusion or limitation of incidental or consequential damages, so the above exclusion may not apply to you. Repair by other than Electro-Voice or its authorized service agencies will void this guarantee.

A list of authorized warranty service agencies is available from Electro-Voice, Inc., 600 Cecil Street, Buchanan, MI 49107 (AC/616-695-6831); Electro-Voice, Inc., 3810 148th Avenue N.E., Redmond, WA 98052 (AC/206-881-9555); and/or Electro-Voice West, 8234 Doe Avenue, Visalia, CA 93291 (AC/209-651-7777). This warranty gives you specific legal rights, and you may also have other rights which vary from state to state.

Service and repair address for this product: Electro-Voice, Inc., 600 Cecil Street, Buchanan, Michigan 49107.

Specifications subject to change without notice.